

①

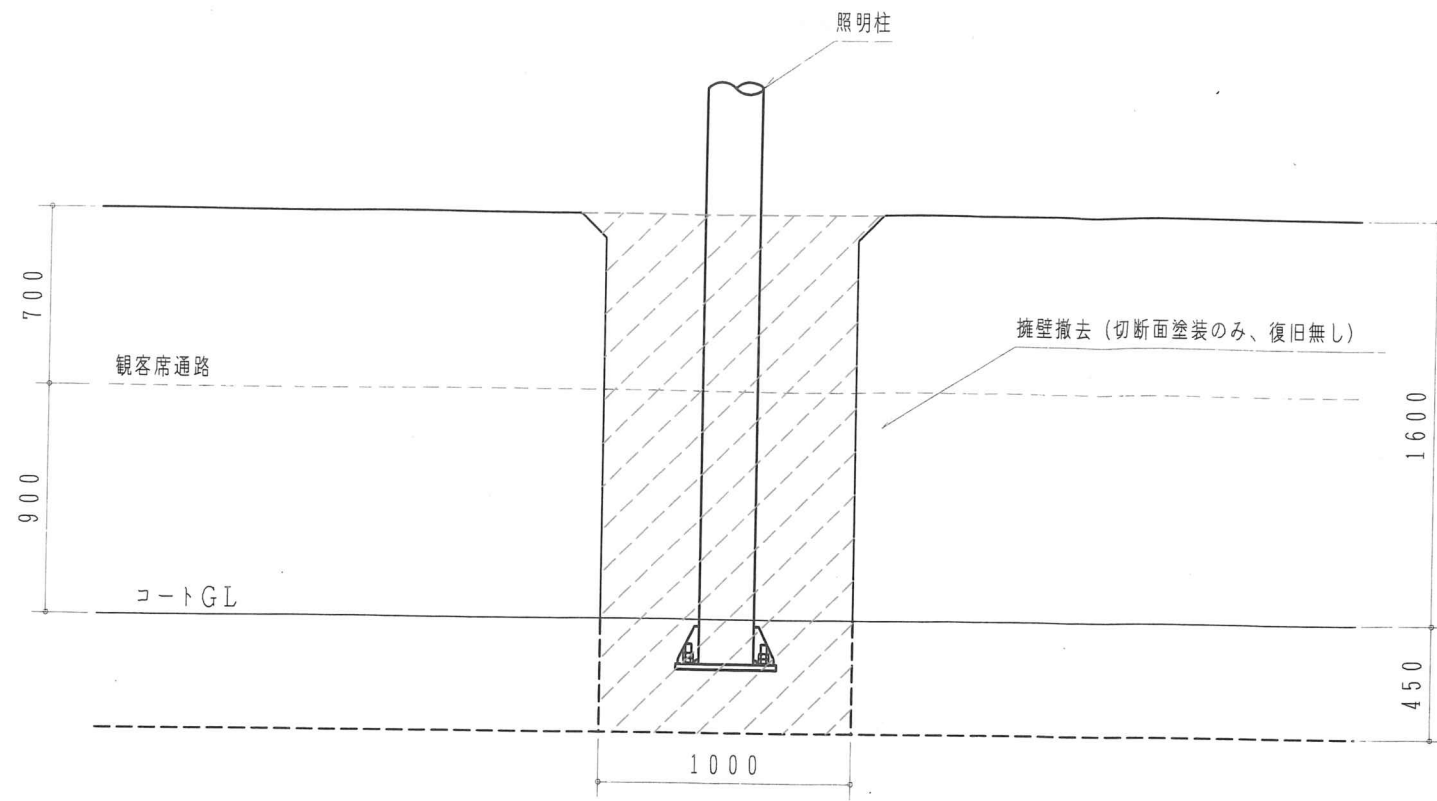

- 舗装版切断
- 擁壁切断
- 擁壁はつり
- 掘削
- 砂
- コンクリート
- 縁石
- アスファルト舗装

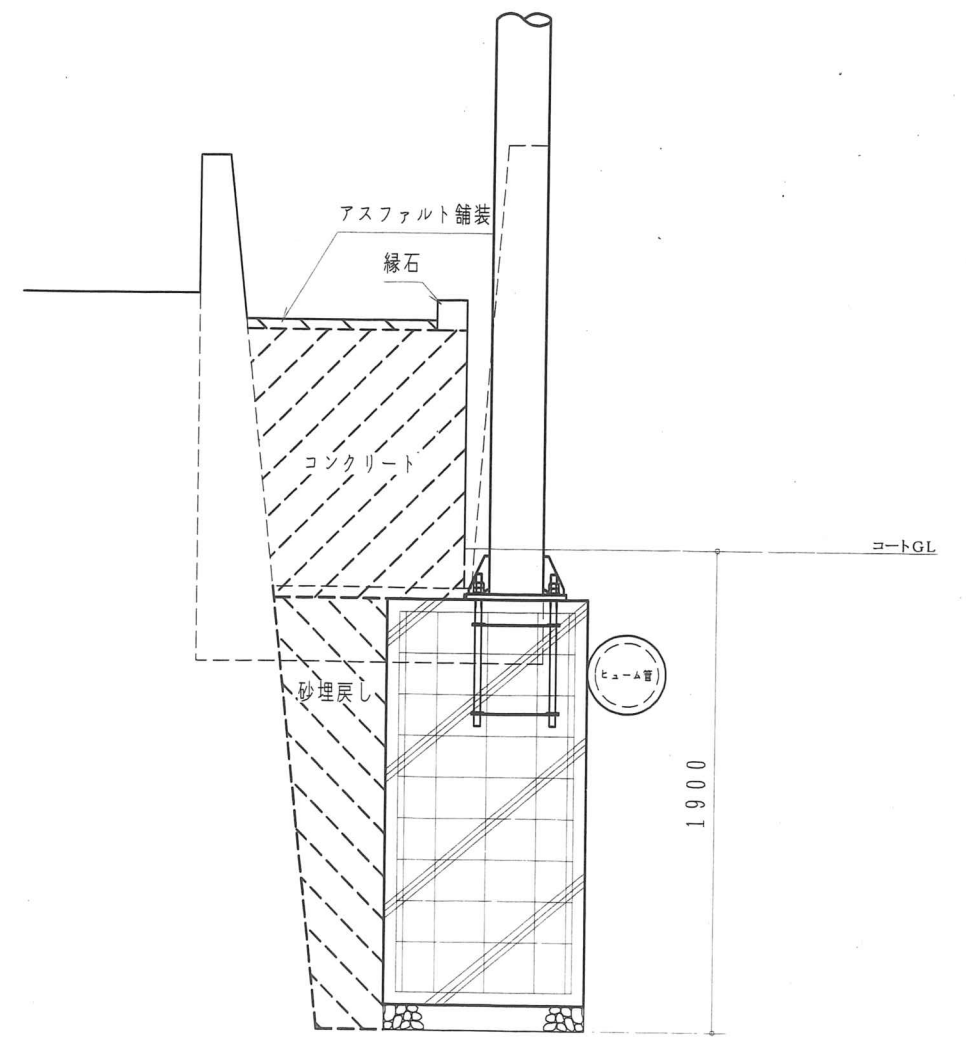
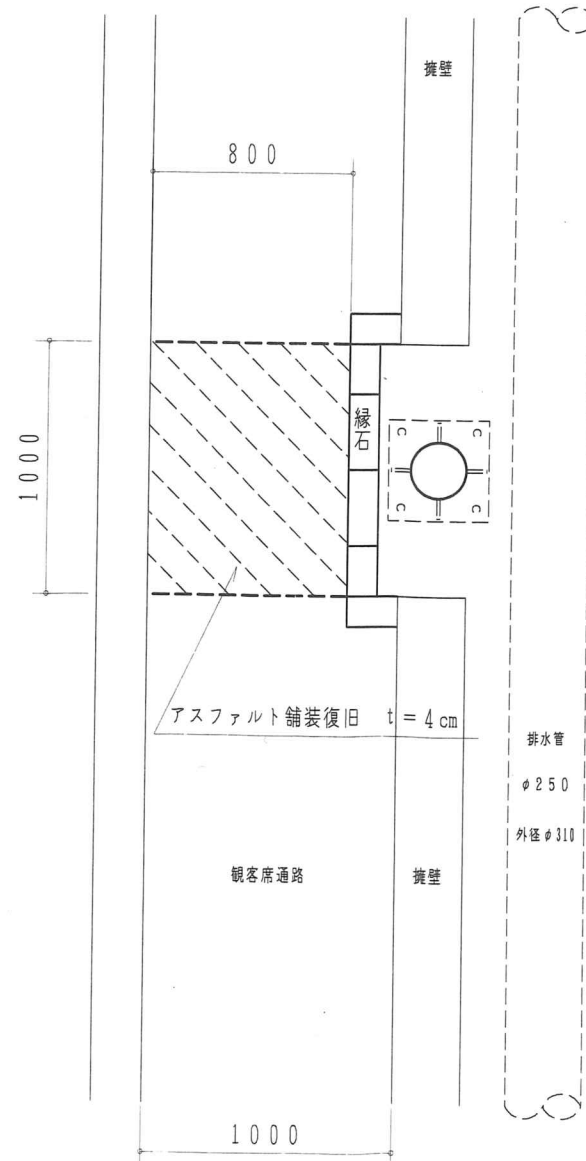
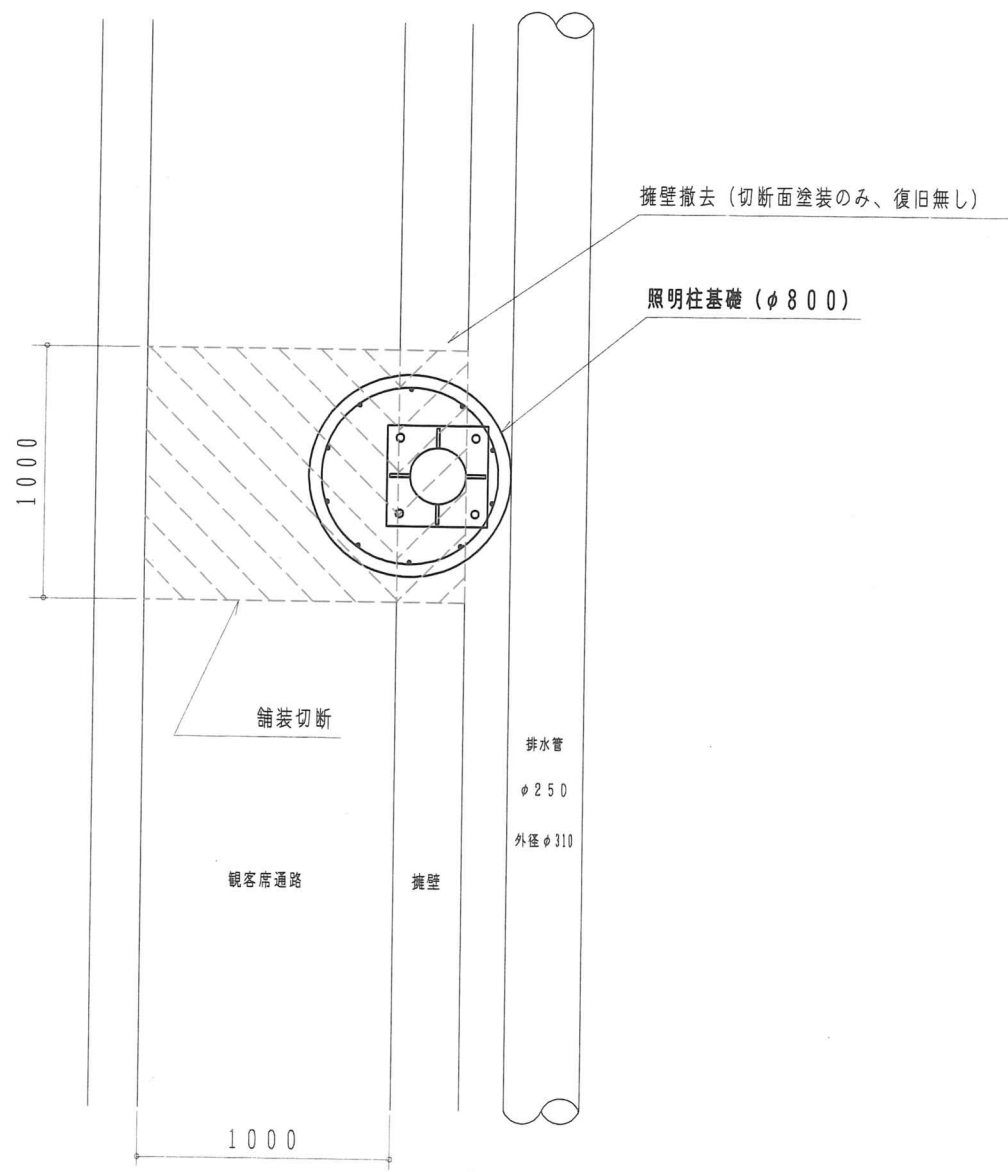

②

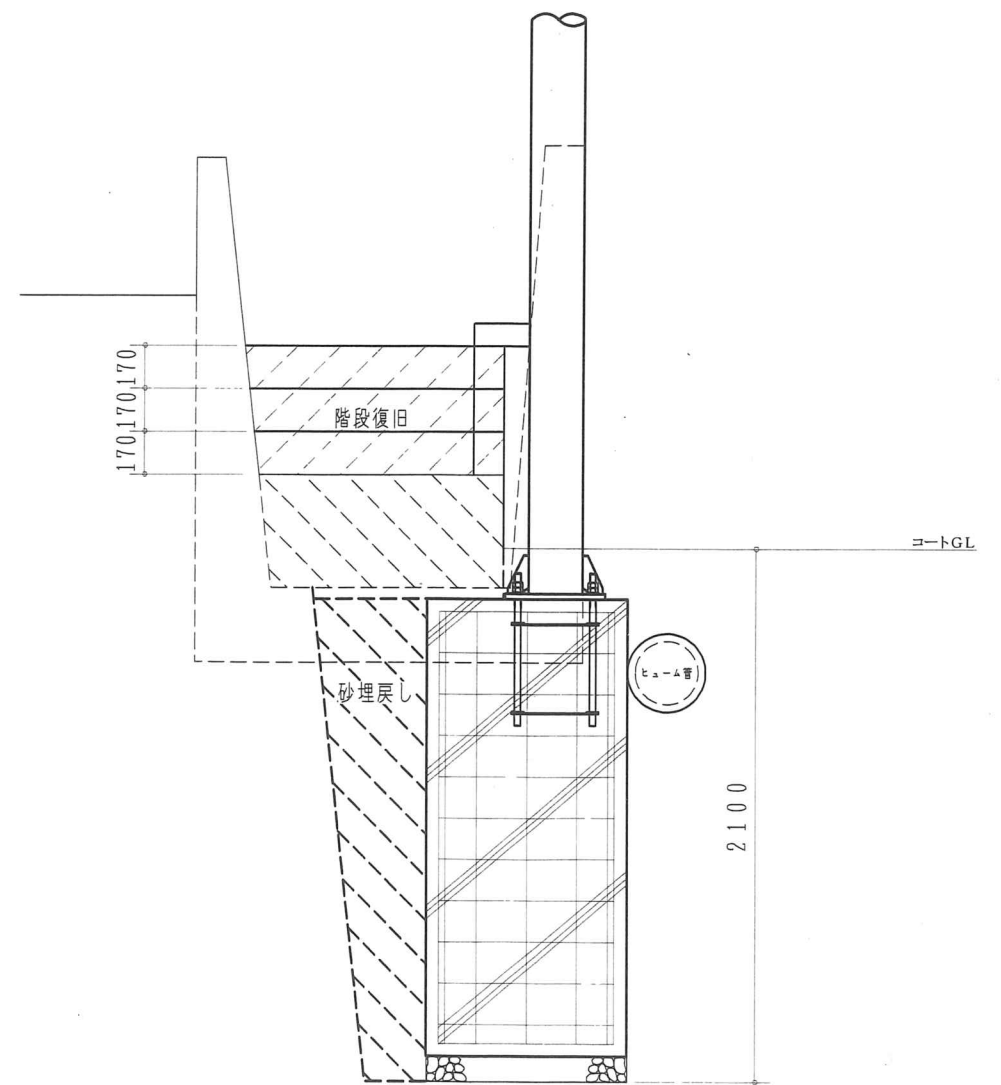
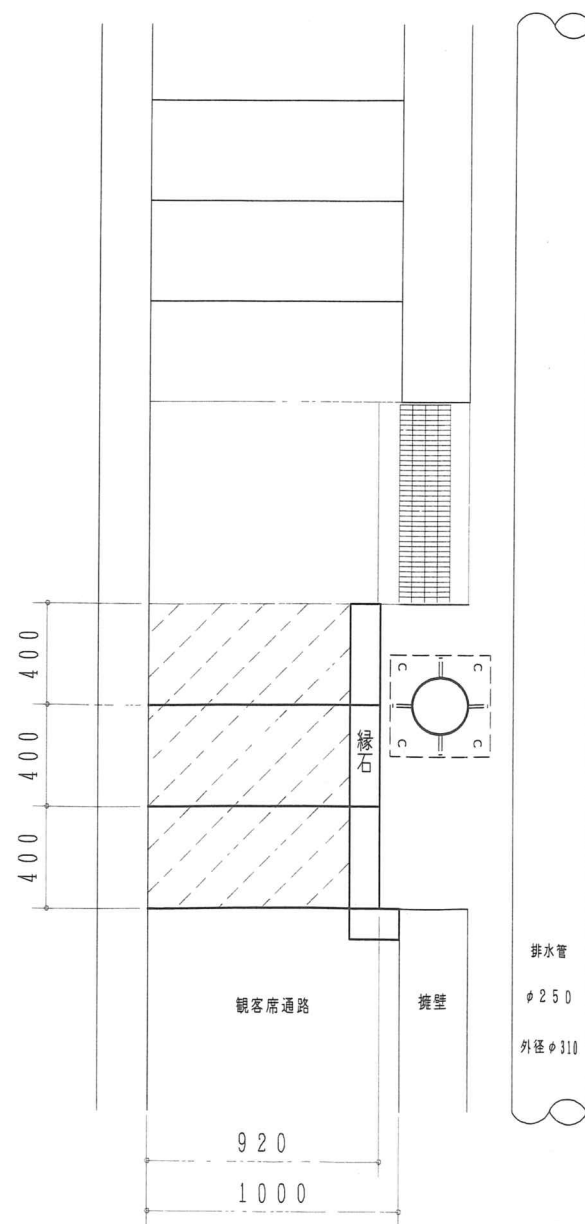
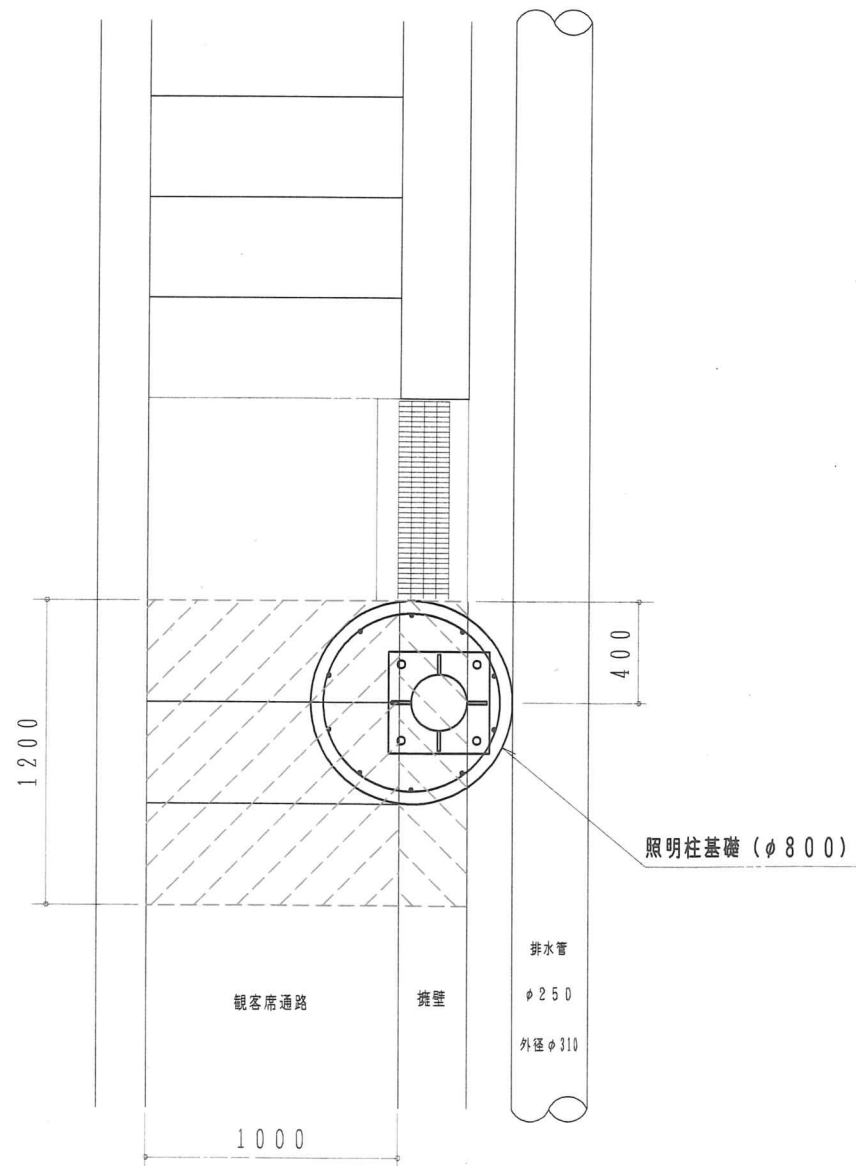
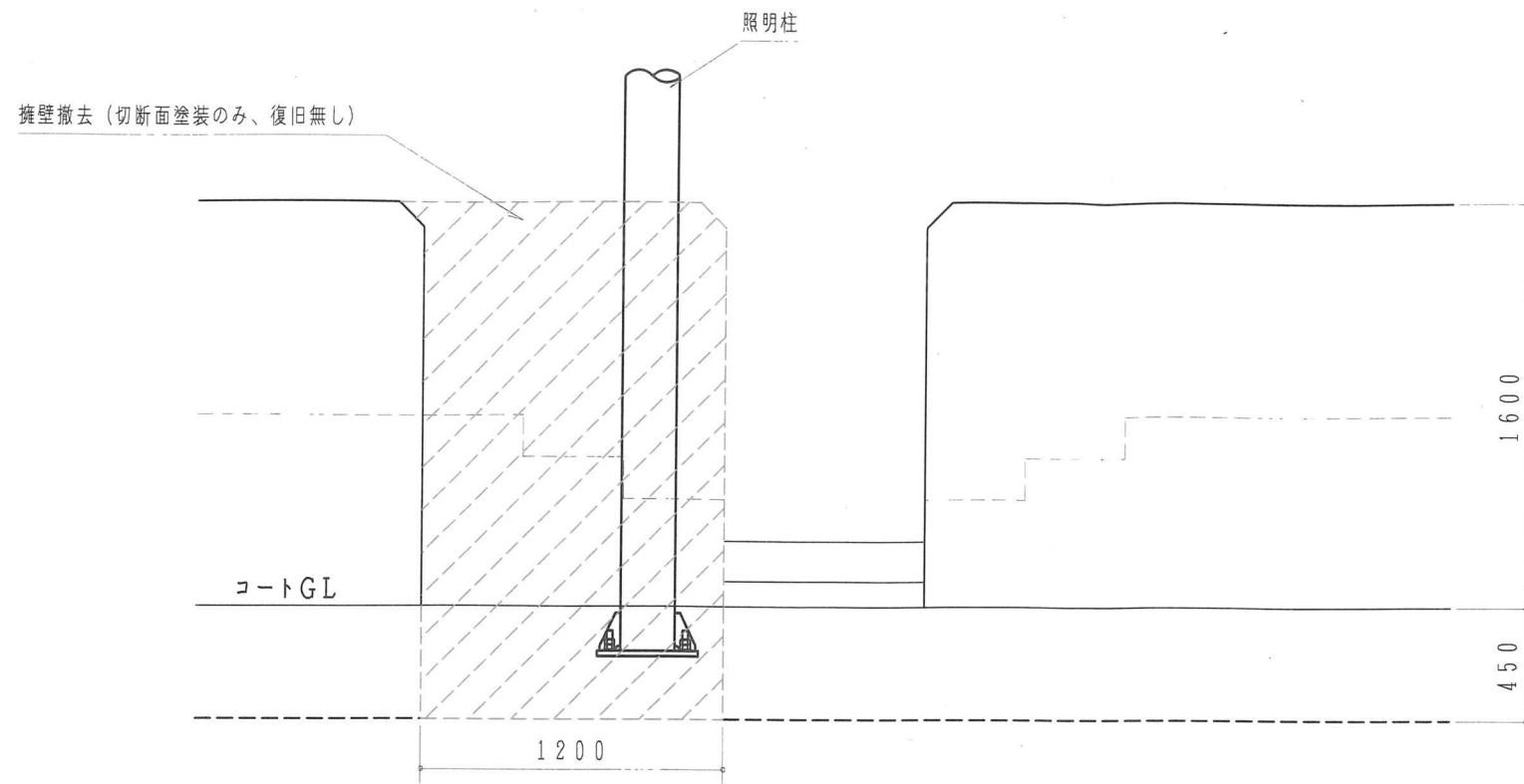

③

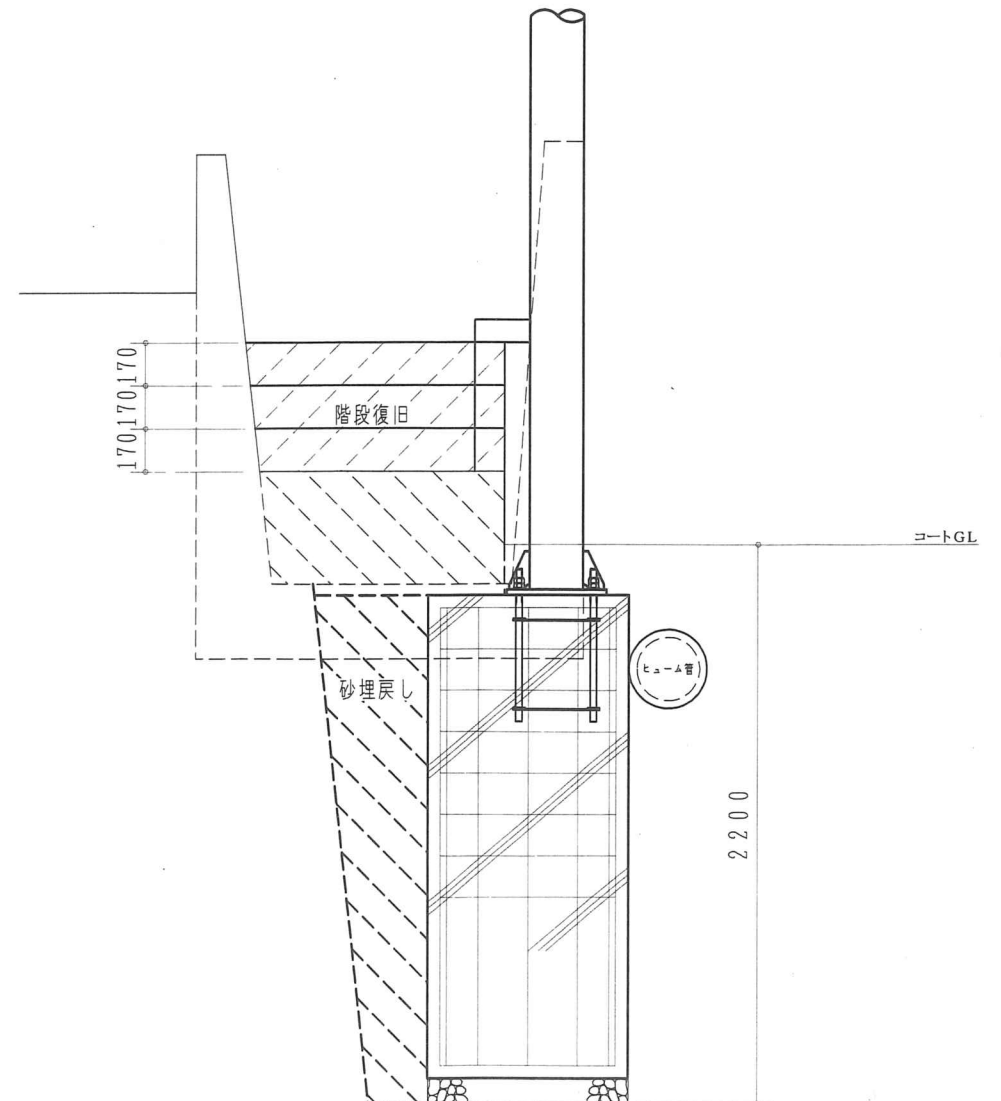
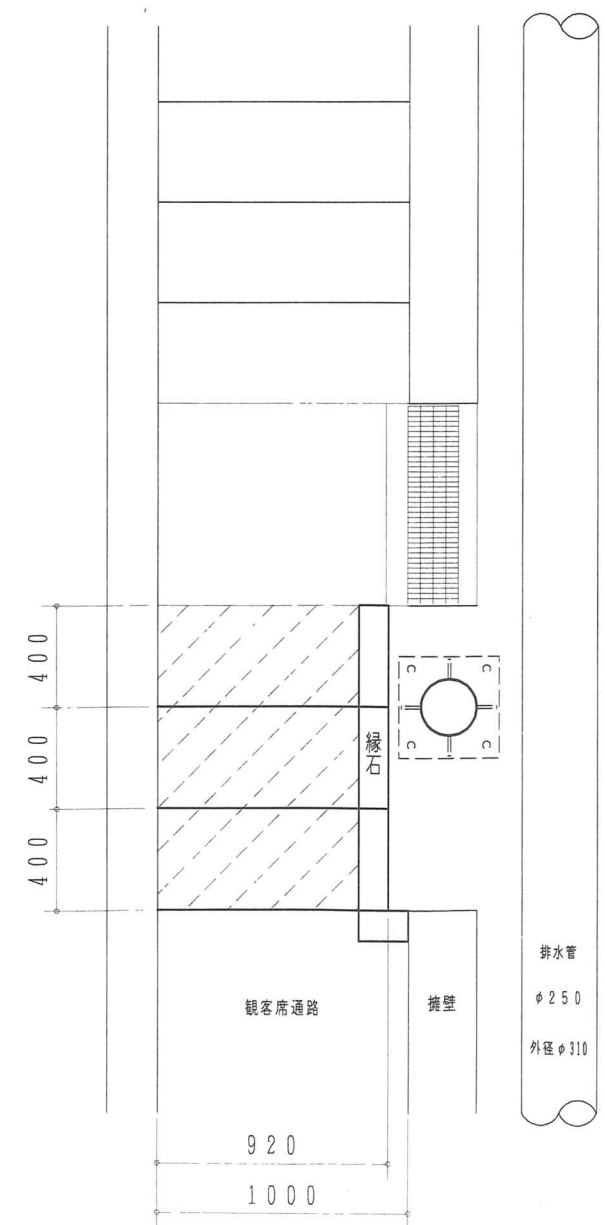
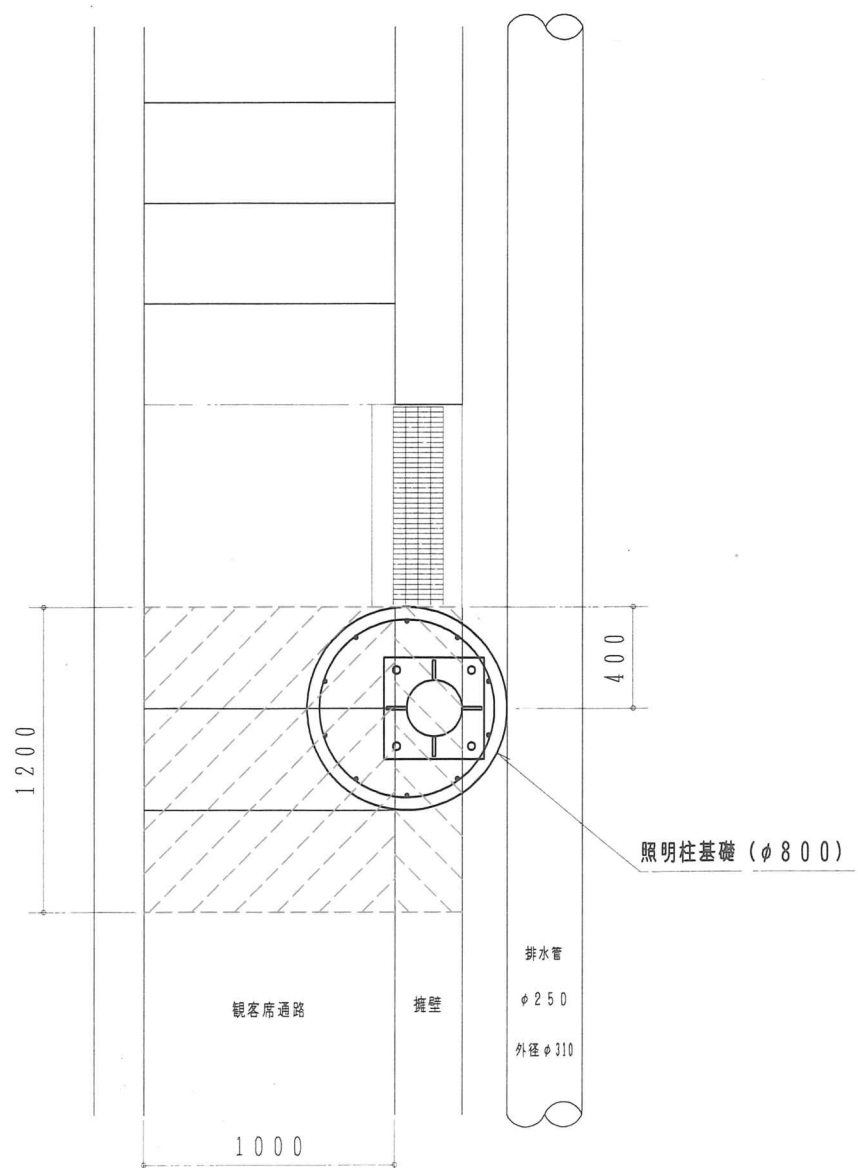
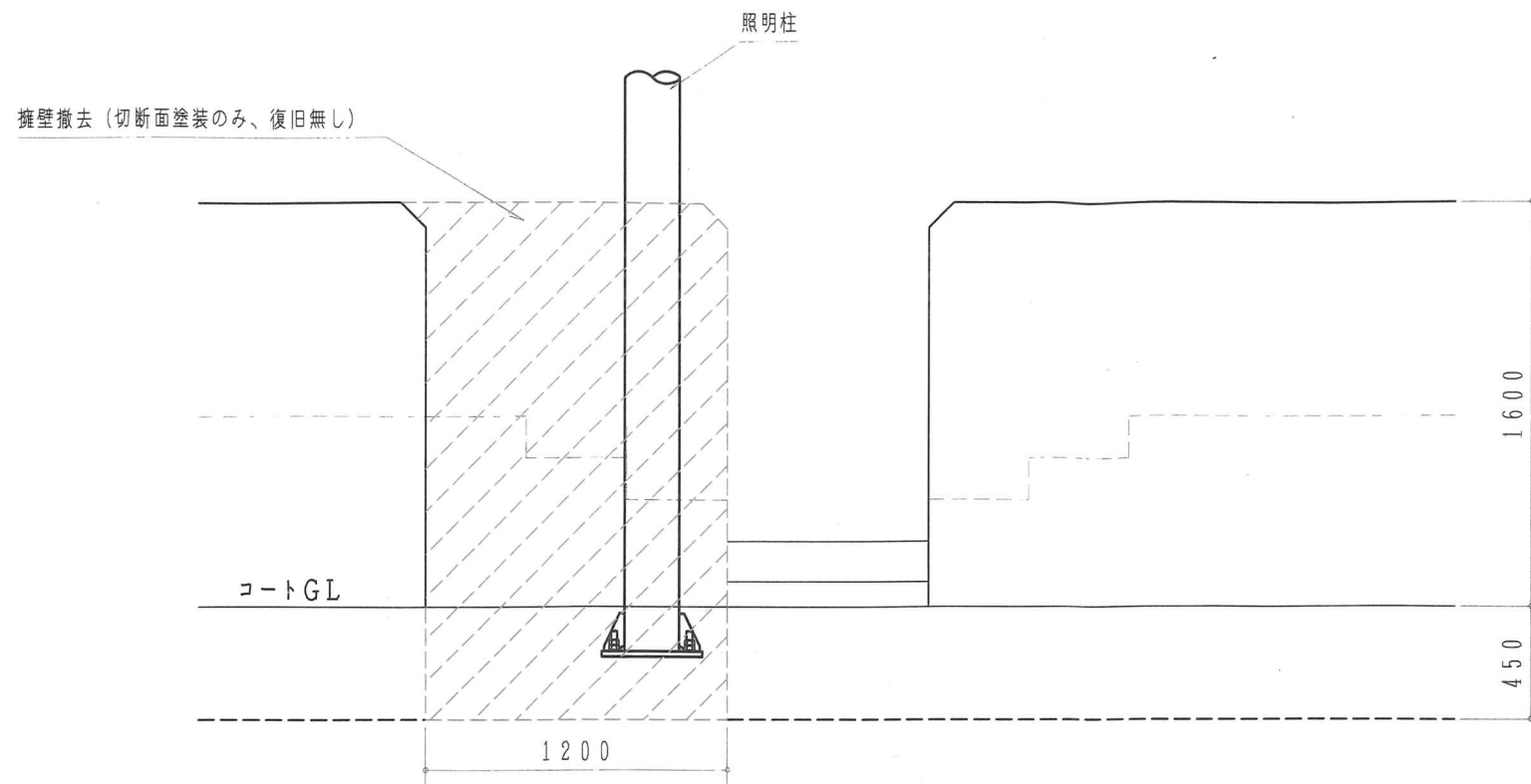

④

